

LAVATHERM 32600

Vented Tumble Dryer

Operating and Installation Instructions



Dear customer,

Please read these operating instructions through carefully, before using the appliance.

Please ensure you fully understand the safety instructions on the first pages of these operating instructions! Retain this instruction book for future reference, and pass on to any future owners.



The warning triangle and/or the key words (**Warning!**, **Caution!**, **Important!**), emphasize information which is important for your safety or the correct functioning of the appliance. It is essential that this information is observed.



This symbol guides you step by step when operating the appliance.



This symbol gives additional information and practical tips on using the appliance.



Tips and information about the economical and environmentally friendly use of the machine are marked with the clover symbol.

If you require assistance or advice on your appliance, please contact our Customer Care Department by letter or telephone:

Customer Care Department
AEG Domestic Appliances
55-77 High Street
Slough
Berkshire SL 1 1DZ
Tel: 08705 350350

Printed on environmentally friendly paper ...
Whoever thinks ecologically also acts ecologically.

Contents

Important Safety Information	5
General Safety	5
Child Safety	6
For the installer – Safety information	7
Technical data	8
Electrical Connection	9
Site Preparation	11
Venting	12
Venting through a Vent Hose	13
Venting without a Vent Hose	14
General Information	15
Disposal	15
Packaging	15
Tumble Dryer	15
Environmental protection tips	16
Description of the appliance	18
Front view	18
Control panel	19
Programme selector	20
Programme selector as progress indicator	20
Before using the appliance for the first time	20
Brief operating instructions	21
Drying	22
Prepare the laundry	22
Open the door	22
Load the laundry	22
Select the drying programme	22
Start the drying programme	23
Removing laundry or loading laundry when necessary	24
End of the drying process	24
Removing the laundry	24
Switch-off the dryer	24
Clean the fluff filter	25

Programme tables	26
A small glossary of textile information	27
Care symbols	27
Cleaning and maintenance	28
Cleaning the filter area	28
Cleaning the drum	28
Cleaning the panel and operating parts	28
Something not working?	29
Door Reversal Instructions	31
Special accessories	33
Stacking kit	33
Vent hose	33
Guarantee Conditions	34
Service & Spare Parts	36
Index	37

Important Safety Information

Your safety is of paramount importance, please ensure you read these warnings before installing or using the appliance. If you are unsure about any of the meanings of these warnings, contact the Customer Care Department.

General Safety

- Any electrical work required to install this appliance should be carried out by a qualified electrician or competent person.
- Please follow the safety instructions in the installation section of this instruction book.
- This appliance is designed to dry normal domestic laundry. If the appliance is used for any other purpose or is incorrectly used, the manufacturer accepts no liability for any damages which may result.
- Switch off the appliance and isolate from the mains supply before carrying out any maintenance or cleaning work.
- Never operate the appliance if the mains cable is damaged or if the control panel, work top or base area are damaged allowing internal components to be accessible.
- Do not spray the tumble dryer with water.
- Do not dry textiles which have been treated with flammable cleaning agents and solvents.
- Clothes or articles of laundry which are dripping wet should not be placed in the dryer. Only load well-spun laundry.
- Laundry items containing sponge rubber or rubber-like materials must be not be dried in the tumble dryer.
- If the drying cycle is interrupted, the laundry or drum may be hot.
- Do not operate the appliance with a damaged filter or with no filter at all.
- Do not overload the appliance.
- It is dangerous to alter the specifications or attempt to modify this product in any way.
- Adaptors and extension cables must not be used. There is risk of fire because of overheating!

- Do not use the mains cable to pull the plug out of the socket.
- Repairs to the appliance should only be carried out by qualified personnel. Repairs carried out by inexperienced persons may cause injury or serious malfunction. Contact your local AEG Service Force Centre for repair.
- Washing that is in poor condition (heavily worn) and items with loose fillings (cushions) that could break open must not be dried or aired. There is a risk of fire!
- Washing with rigid components (foot mats) will cover the air slots; the slots will also be covered if the drum is overfilled. Observe the maximum load of 5 kg. There is a risk of overheating which could cause a fire!
- Only dry washing that does not contain any explosive objects (fire lighters, spray cans). There is a risk of fire or an explosion!
- In the case of washer / dryer tower combinations, do not place any objects on the dryer during use as they could drop down.

Child Safety

- The appliance is designed to be operated by adults. Children should not be allowed to tamper with the controls or play with the appliance.
- Pets and children have been known to climb into tumble dryers. Please check the drum before use.
- Keep all packaging away from children.
- When disposing of the appliance, cut off the mains cable and destroy the plug. Disable the door catch to prevent young children being trapped inside.

For the installer – Safety information

- Check the appliance for transportation damage before installation.
- Any electrical work required to install this appliance should be carried out by a qualified electrician or competent person.
- This tumble dryer is designed to be vented through to the open air. It should have its own ventilation system which should not be joined with any other ventilation system connected to any other appliance.
- The dryer must not be vented into a chimney, or flue pipe designed to carry the exhaust from a fuel burning heating appliance.
- If the tumble dryer is installed next to a fuel burning stove, a heat insulation non-flammable pad must be inserted between the fuel burning stove and the tumble dryer: (dimensions 85 x 57 cm).
- If the dryer is installed in a room with a fuel burning heating appliance, consult your local Corgi registered installer.
- The tumble dryer should not be installed in situations which may be subject to freezing temperatures.
- The installation site must be well ventilated.
- Ensure the appliance does not stand on the electrical supply cable.
- If the machine is situated on carpeted floor, please adjust the feet in order to allow air to circulate freely.
- The tumble dryer must be level.
- Observe the safety precautions in the operating instructions for your dryer.
- Air is drawn in through vents at the rear and front of this appliance. Therefore, keep the area around the appliance clear.

Technical data

Height x Width x Depth	85x60x60cm
Depth with the door open	117cm
Height adjustable from	1.0/-0.4cm
Empty weight	approx. 40kg
Load (depending on the programme)	max. 5kg
Power consumption in acc. with IEC 1121 s.e. (5 kg Cotton, spun at 800 revolutions per minute)	3.4kWh
Area of use	Household
Permissible ambient temperature	+5°C up to +35°C

- CE** This appliance complies with the following EC directives:
- 73/23/EEC of 19/2/1973 'Low voltage directive'
 - 89/336/EEC of 3/5/1989 'EMC directive' including the Modification directive 92/31/EEC

Electrical Connection

Any electrical work required to install this appliance should be carried out by a qualified electrician or competent person.



WARNING – THIS APPLIANCE MUST BE EARTHED.

The manufacturer declines any liability should these safety measures not be observed.

Before switching on, make sure the electricity supply voltage is the same as that indicated on the appliance rating plate. The rating plate is located inside the door.

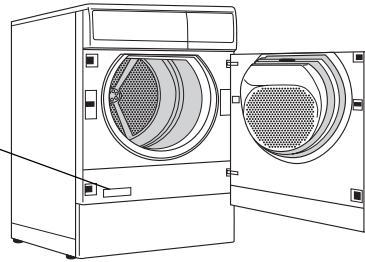
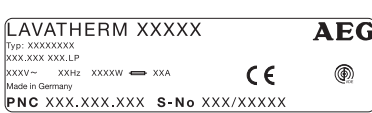

The appliance is supplied with a 13amp plug fitted. In the event of having to change the fuse in the plug supplied, a 13amp ASTA approved (BS 1362) fuse must be used.

Should the plug need to be replaced for any reason. The wires in the mains lead are coloured in accordance with the following code:

Green and Yellow	: Earth
Blue	: Neutral
Brown	: Live

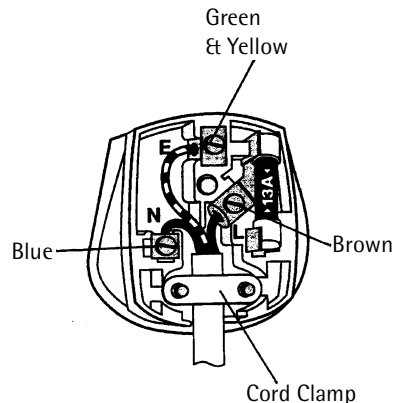

- The wire coloured green and yellow must be connected to the terminal marked with the letter "E" or by the earth symbol \oplus or coloured green and yellow
- The wire coloured blue must be connected to the terminal "N" or coloured black.
- The wire coloured brown must be connected to the terminal marked "L" or coloured red.
- Upon completion there must not be cut, or stray strands of wire present and the cord clamp must be secure over the outer sheath.



WARNING: A cut off plug inserted into a 13 amp socket is a serious safety (shock) hazard. Ensure that the cut off plug is disposed of safely.

Permanent connection

In the case of a permanent connection it is necessary that you install a double pole switch between the appliance and the electricity supply (mains), with a minimum gap of 3 mm between the switch contacts and of a type suitable for the required load in compliance with the current electrical regulations.

The switch must not break the yellow and green earth cable at any point.

Site Preparation

- The installation surface must be clean and dry.
- Do not install on a deep pile carpet.
- If the appliance is installed next to a heat source (e. g. cooking appliance), a heat insulation pad (85 x 57 cm) must be placed between the washing machine and the heat source.
- Do not install the appliance where the temperature may fall below freezing or rise above 35°C.
- Please ensure that when the appliance is installed it is easily accessible for the engineer in the event of a breakdown.

Levelling the Appliance

The appliance must be levelled using the adjustable feet. Use a screwdriver to adjust to the feet until the appliance is level.

Venting

The appliance expels hot, moist air which must be able to flow freely from the tumble dryer vent.

Tumble Dryer Vents

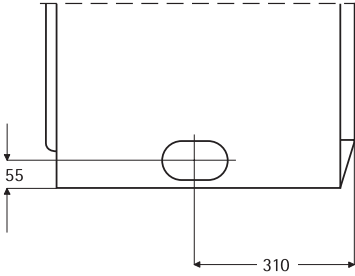

View from left

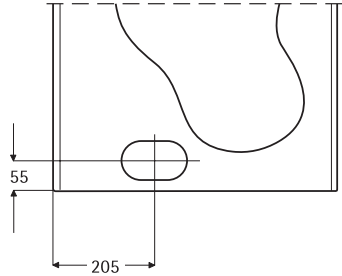

Rear view

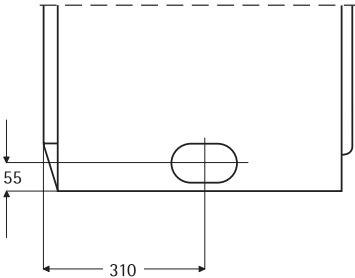

View from right

The most efficient way of venting the expelled air is via a vent hose through to the outside.

Venting through a Vent Hose

The vent hose expelling the hot air should be 100 mm diameter and no longer than 4 meters. Avoid bends in the vent hose as this will reduce the air flow. The maximum length of the vent hose may be:

4 meters with 0 bends, or

2 meters with 2 bends.

If the vent hose is to be permanently installed to the outside, a wall vent kit or suitable cover should be used on the outside wall.

Example:

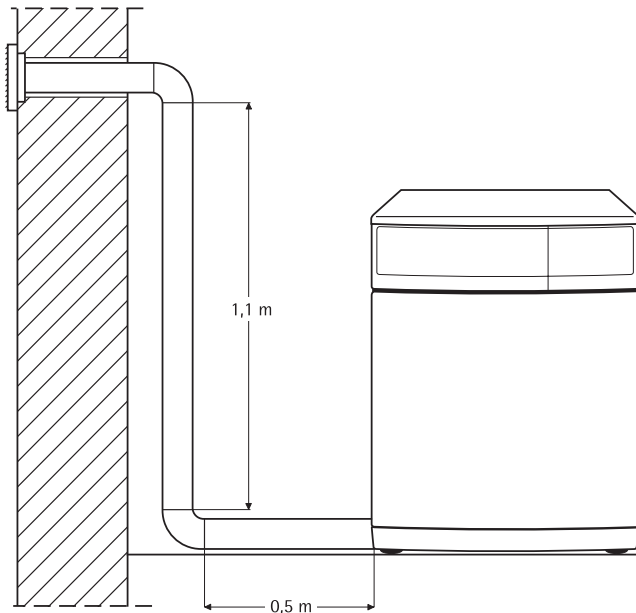

A vent hose (Part number: 647 000 010) and wall vent kit (Part number: 647 000 020) are available from your local AEG Service Force Centre.

Ensure the vent hose is not squashed. The drying efficiency of the tumble dryer will be affected and may cause the safety cut outs to operate.



Warning! The vent hose must not be connected to a flue pipe or chimney designed to carry the exhaust from a fuel burning heating appliance.

Venting without a Vent Hose

If a vent hose is not connected to the tumble dryer, the air can be expelled into the installation room providing the following precautions are observed.

- The vent(s) in use must be at least 30 cm from the wall or any other object.
- Any vent less than 30 cm from a wall or other object must be closed using the cover provided.
- The installation room must be well ventilated during the drying cycle.

General Information

- To prevent creasing do not exceed the maximum load stated in the programme table.
- When using fabric conditioning sheets, we recommend the conditioning sheet is pinned (using a safety pin) to an article of laundry and placed in the tumble dryer.
- When using fabric conditioning sheets or drying starched washing in the tumble dryer, it is important to clean the drum to prevent a build up of any residues/deposits. See maintenance and cleaning section.
- Please ensure the appliance is easily accessible to an engineer after installation.

Disposal

Packaging

- Dispose of the packaging material correctly. All packaging materials are environmentally friendly and can be disposed of without any danger to the environment.
- The external plastic covering and bags inside are made of Polyethylen (marking >PE<).
- The padding is made of CFC free expanded polystyrene (marking >PS<).

Tumble Dryer

When disposing of the tumble dryer.

- Cut off the mains cable and destroy the plug.
- Disable the door catch to prevent young children becoming trapped inside.
- Use an authorised disposal site.



Environmental protection tips

- Your laundry will become light and soft in the tumble dryer even without a fabric softening agent.
- Loosen your laundry before loading it into the dryer. This helps to prevent lengthy running times and creasing. Ensure your laundry is well spun.

In the following table we give an overview of specific electric consumption data depending on the spinning speed. This information is valid for 5kg laundry:

Spinning/wringing out:			Drying cycle:	
Revolutions per minute	Residual dampness		Time required in minutes	Energy requirement in kWh
	in litres	in %		
800	3.5	70	80	3.4
1000	3.0	59	70	2.9
1200	2.7	53	65	2.6
1400	2.5	50	60	2.4
1600	2.2	44	55	2.2

- Observe the maximum load instructions. Whenever possible, dry full loads.
- Select the appropriate drying programme for the type and quantity of laundry. The dryer will then operate as economically as possible. Some typical consumption values:

Type of washing	Desired degree of dryness	Load in kg	Duration in minutes	Power consumption in kWh
Cotton ¹	Cupboard dry	5	80	3.4
Cotton ¹	Hand iron	5	65	2.5
Mixed fabrics ²	Cupboard dry	2.5	35	1.3

1) Spun with 800 revolutions per minute

2) Prespun with 1000 revolutions per minute

- Only use the **S** SPECIAL CARE button for loads up to 2.5kg.
- Clean the fluff filter after every drying programme!

Description of the appliance

Front view

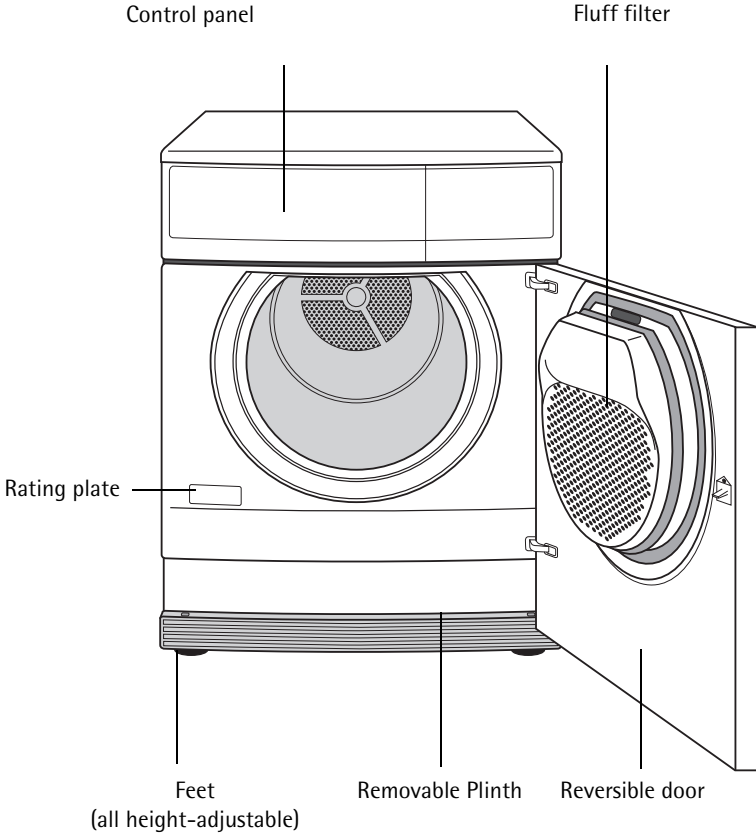

Control panel

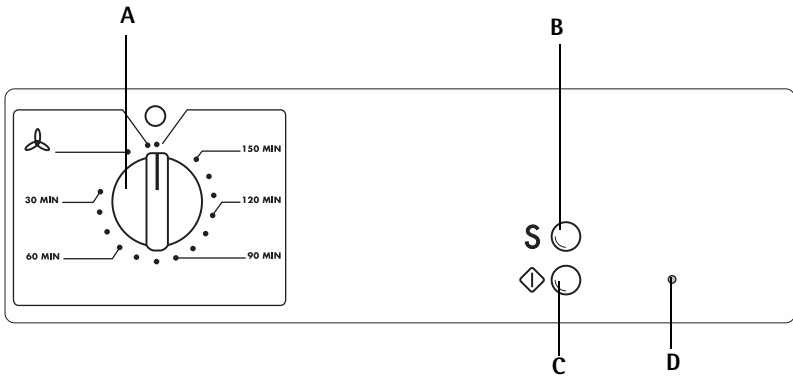



A Programme selector: To select the drying time required

B SPECIAL CARE button **S**: For delicate fabrics

C START button **◇**: For starting the drying programme

D OPERATING light: illuminates when the appliance is switched on

Programme selector

- 150 MIN - 30 MIN:
for setting the drying time
required in minutes.
- AIRING programme :
for smoothing out creased outer
garments in a cold air flow;
slightly dampen the creased areas
first;
programme duration: 10 minutes.
- OFF :
The tumble dryer is switched off.

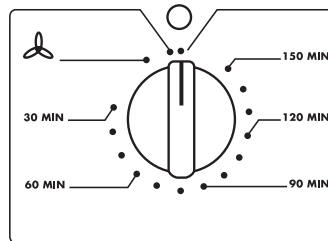

Programme selector as progress indicator

The programme selector serves as a progress indicator by moving clock-wise until the end of the programme is reached.

Before using the appliance for the first time

-  Wipe the drum of the dryer with a moist cloth.

Brief operating instructions

- Ensure the laundry is well spun before tumble drying.
- Prepare the laundry.
- Load the laundry.
- Select the drying programme using the programme selector.
 - Press the **S** SPECIAL CARE button if required.
- Start the programme.

While the programme is running you can open the door to remove or add laundry.

At the end of the programme:

- Remove the laundry.
- Clean the fluff filter.
- Switch-off the dryer.

Drying

Prepare the laundry

- To prevent tangled bundles of laundry: Close zip fasteners; button-up bed linen and pillow cases; tie-together loose tapes, e.g. aprons.
- Empty all pockets.
- Remove all metal objects (paper clips, pins, etc.).
- Turn clothing consisting of double-layer fabric inside out (such as cotton-lined anoraks with the cotton layer facing outwards). The fabrics will dry better.
- Loosen the laundry.

Open the door

To open the door:

- Press firmly against the door (Press position ).

Load the laundry



Caution! Ensure the laundry does not get caught in the door when the door is closed! This could damage the laundry!

- Load the prepared laundry into the dryer.

Select the drying programme



Select the suitable drying programme using the programme selector (see "Programme tables").

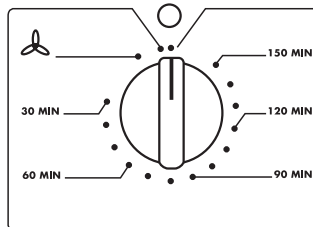

If required, select the button **S** SPECIAL CARE.



- SPECIAL CARE button

This programme operates with reduced heat.

Press the SPECIAL CARE button for fabrics bearing the care symbol . Gentle drying is advisable for heat-sensitive fabrics (such as acrylic and viscose).

Start the drying programme

 Press the START button.





Removing laundry or loading laundry when necessary

You can interrupt the drying process at any time to remove some of the laundry or to add more laundry.

 Open the door.

 **Caution!** The laundry and the drum may be hot.

 Remove or add more laundry.

 Close the door.

 Press the START button to resume the drying process.

End of the drying process

The **cooling phase** starts shortly before the end of the drying process: The heater is switched-off during this phase.

After the cooling phase you can remove the laundry from the dryer.

The **crease guard phase** follows automatically after the drying process. The drum rotates intermittently. This keeps your laundry loose and crease-free.

Removing the laundry

 Open the door and remove the laundry.

Switch-off the dryer

 Turn the programme selector to  OFF.

Clean the fluff filter

To ensure efficient operation of the tumble dryer, clean the fluff filter after each drying programme.

Also check whether there are any remnants or fluff from the washing in the drum; remove immediately.

-  Press the catch of the filter lid downwards.

The filter lid will open.

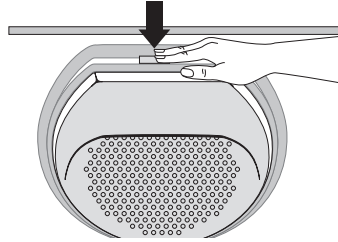



-  Take-out the fluff filter.

-  Remove fluff out of the fluff filter, with a moistened hand.

-  Re-insert the fluff filter.

-  Press against the filter lid until it catches into the locking device.

-  The filter lid cannot catch shut without the fluff filter in place and the door cannot be closed.

-  **Warning!** The dryer must not be operated with a damaged or blocked fluff filter.

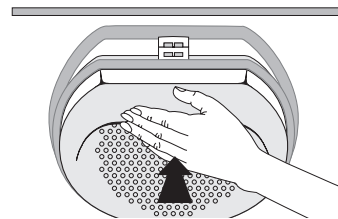
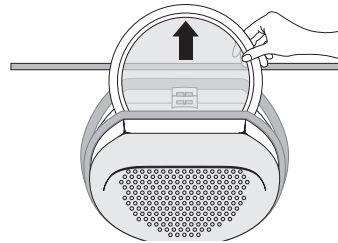

Programme tables

When spun at 1000 revolutions per minute

Type of washing	Examples for washing/fabrics	Load in kg	Drying time	
			Normal	Special Care button S
Thick or multi-layer cottons which have to be thoroughly dried.	Towelling laundry, bath robes, towels	5	70	--
		2	35	65
Thick or multi-layer cottons which require ironing.	Sheets, pillow cases, duvet covers, table cloths and napkins, teatowels	5	55	--
		2	30	55
Easy-care washing, synthetics and mixed fabrics, which do not need any further care (e.g. ironing).	Easy-care, shirts, sheets, pillow cases, duvet covers, table cloths and napkins	2.5	30	50

When spun with 1200 revolutions per minute

Type of washing	Examples for washing/fabrics	Load in kg	Drying time	
			Normal	Special Care button S
Thick or multi-layer cottons which have to be thoroughly dried.	Towelling laundry, bath robes, towels	5	65	--
		2	30	60
Thick or multi-layer cottons which require ironing.	Sheets, pillow cases, duvet covers, table cloths and napkins, teatowels	5	50	--
		2	25	50





AIRING programme

The washing is treated for 10 minutes in a cold stream of air for smoothing out creased outer garments.

A small glossary of textile information

Care symbols

Ensure articles to be dried are suitable for tumble drying. If they are one of the following symbols should be present on the care label:

-  Normal drying
-  Drying with special care (press the **S** SPECIAL CARE button!)
-  This fabric can be tumble dried. The fabric manufacturer does not stipulate if the piece of laundry should be dried on a normal or gentle programme.
-  Do not tumble dry

If you do not find any of these care symbols:







Dry whites and coloureds as well as mixed fabrics at normal temperature. Press the **S** SPECIAL CARE button if you are drying delicate fabrics.

- Wool
Do not dry any woollen items in the dryer.
- Fabrics sensitive to temperatures
Dry fabrics sensitive to temperatures (such as acrylic or viscose) and textiles with the care label  with the **S** SPECIAL CARE button.
- Cotton jersey and hosiery have a tendency to shrink! Do not dry these fabrics excessively.
- New coloured textiles
To avoid the possibility of dye transference do not dry new coloured textiles together with light-coloured laundry.

Cleaning and maintenance

Cleaning the filter area

 **Important!** A small amount of fluff may reach the area around the fluff filter. Therefore, you should clean the entire filter area from time to time, or at least every three months.

-  Remove the fluff filter.
-  Hold the filter lid by the top and pull it forwards until it is released from both holders.
-  Remove the fluff from the entire filter area – preferably with a vacuum cleaner.
-  Press both pins of the filter lid into the holders on the door until they click in.
-  Reinsert the fluff filter.
-  Press against the filter lid until it clicks into the lock.

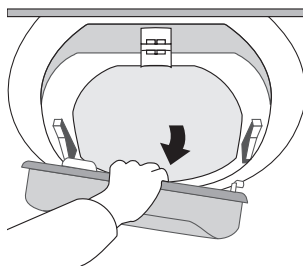



Cleaning the drum

 **Warning!** Do not clean the stainless steel drum with abrasive detergents or steel wool!

-  Wipe the inside of the drum and the drum fins with white vinegar to avoid a build up of residues/deposits. This is particularly important if you regularly use fabric conditioning sheets or dry starched items in the dryer.

Cleaning the panel and operating parts

 **Warning!** Do not use household furniture polish or aggressive detergents.

-  Wipe over the panel and operating parts with a damp cloth. Only use warm water.

Something not working?

If the tumble dryer is not working correctly please carry out the following checks before calling an engineer.

Symptom	Possible cause	Solution
The tumble dryer will not start	The appliance is not plugged in	Plug in the appliance
	The fuse has blown	Check the fuse
	The ◊ START button has not been pressed	Press the ◊ START button
	No programme has been selected	Select the required programme
	The door is not properly closed	Close the door
The results are unsatisfactory	The wrong programme has been selected	Select a different programme
	Fluff filter blocked	Clean the fluff filter
	The tumble dryer has been overloaded	Observe the maximum loads stated for each programme
	Laundry not sufficiently spun prior to tumble drying	Ensure the wash load is well spun before tumble drying
The drying process takes unusually long	The vent hose may be obstructed	Check the vent is not blocked or squashed
	Fluff filter is clogged	Clean the fluff filter
The door cannot be closed	Fluff filter has not been inserted correctly and/or the filter lid not closed	Replace the fluff filter and ensure the filter lid is closed

If after these checks, the tumble dryer still does not work, contact your local AEG Service Force Centre.

Please note that it will be necessary to provide proof of purchase for any in-guarantee service calls.

In-guarantee customers should ensure that the above checks have been made as the engineer will make a charge if the fault is not a mechanical or electrical breakdown.

Door Reversal Instructions





The door opening direction can be changed if required.



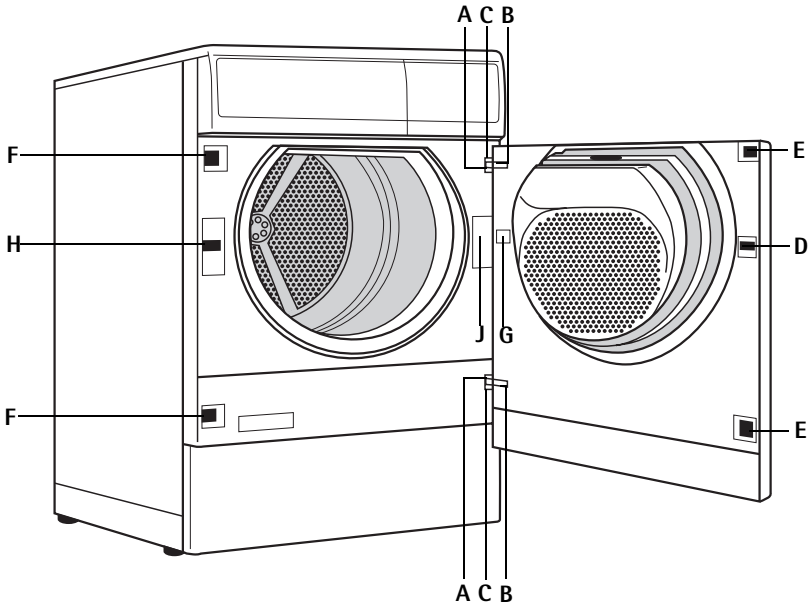





Warning! Before reversing the door, isolate the appliance from the mains supply.

Proceed as follows to reverse the door opening direction:



-  Remove the screws A on the front panel of the appliance.
-  Take off the door by sliding the door towards the centre of the machine, disengaging the hinges from the front panel.
-  Remove the screws B on the inside of the door and take off the hinges C.
-  Remove the screw and slide out the door catch D.
-  To release the coverplates E, F & G use a small screwdriver to depress the small round plastic locating peg and simultaneously push the cover plate towards the peg.

-  Reposition hinges C and door catch D on the opposite side of the door and replace screws.
-  To release the door lock H remove the fixing screw and slide the lock upwards. To disconnect the wiring plug press the two plastic securing levers on the plug and pull out.
-  Coverplate J is removed as E, F & G above. Disconnect the wiring plug by pressing the two plastic securing levers on the plug and pull out.
-  To reconnect door catch H on the opposite side of the appliance connect the wiring plug, insert the lock and replace screw.
-  Attach wiring plug to coverplate J and clip in place.
-  Reposition door on the opposite side of the appliance by inserting the hinges and secure with screws.



Warning! The appliance must not be operated until all plastic parts have been refitted.

Special accessories

You can obtain the following special accessories from your retailer.

Stacking kit

With these kits you can combine your laundry dryer with any LAVAMAT automatic washing machine to a washing and drying column. The appliances are stacked in space-economising manner in this arrangement, the washing machine at the bottom and the laundry dryer at the top.

The following two kits are available:

- without plate E-No. 916 018 900
- with extendible deposit plate E-No. 916 018 901

Vent hose

To conduct exhaust fumes, a flexible spiral conduit with a diameter of 105 mm can be obtained through your AEG Service Force Centre or at a specialised electrical shop. This spiral conduit is easy to fit and is easily attached to the vented tumble dryer using the adapter that comes with the appliance (see p. 13 and enclosed booklet „Installation Instructions for Vented Tumble Dryer“).

Guarantee Conditions

AEG offer the following guarantee to the first purchaser of this appliance.

1. The guarantee is valid for 12 months commencing when the appliance is handed over to the first retail purchaser, which must be verified by purchase invoice or similar documentation.
The guarantee does not cover commercial use.
2. The guarantee covers all parts or components which fail due to faulty workmanship or faulty materials. The guarantee does not cover appliances where defects or poor performance are due to misuse, accidental damage, neglect, faulty installation, unauthorised modification or attempted repair, commercial use or failure to observe requirements and recommendations set out in the instruction book.

This guarantee does not cover such parts as light bulbs, removable parts of glass or plastic, dust bags or filters.

3. Should guarantee repairs be necessary the purchaser must inform the nearest customer service office (manufacturer's service or authorised agent). AEG reserves the right to stipulate the place of the repair (i. e. the customer's home, place of installation or AEG workshop).
4. The guarantee or free replacement includes both labour and materials.
5. Repairs carried out under guarantee do not extend the guarantee period for the appliance. Parts removed during guarantee repairs become the property of AEG.
6. The purchaser's statutory rights are not affected by this guarantee.

European Guarantee

If you should move to another country within Europe then your guarantee moves with you to your new home subject to the following qualifications:

- The guarantee starts from the date you first purchased your product.
- The guarantee is for the same period and to the same extent for labour and parts as exist in the new country of use for this brand or range of products.
- This guarantee relates to you and cannot be transferred to another user.
- Your new home is within the European Community (EC) or European Free Trade Area.
- The product is installed and used in accordance with our instructions and is only used domestically, i. e. a normal household.
- The product is installed taking into account regulations in your new country.

Before you move please contact your nearest Customer Care Centre, listed below, to give them details of your new home. They will then ensure that the local Service Organisation is aware of your move and able to look after you and your appliances.

France	Senlis	+33 (0) 3 44 62 29 29
Germany	Nürnberg	+49 (0) 911 323 2600
Italy	Pordenone	+39 (0) 1678 47053
Sweden	Stockholm	+46 (0) 8 738 7910
UK	Slough	+44 (0) 1753 219899

Service & Spare Parts

If after carrying out the necessary checks there is still a fault with your appliance please contact your local AEG Service Force Centre.

In guarantee customers should ensure that the suggested checks have been made as the engineer will make a charge if the fault is not a mechanical or electrical breakdown.

Please note that proof of purchase is required for in-guarantee service calls.

Service & Spare Parts

If you require a service engineer or wish to purchase spare parts, contact your local AEG Service Force Centre, by telephoning

08705 929 929

Help us to help you

Please determine your type of enquiry before telephoning. When you contact us we need to know.

1. Your name, address and post code.
2. Your telephone number.
3. Clear and concise details of the fault.
 - What is the fault?
 - When does the fault occur?
4. The model, production number and product identification number.
5. Date of purchase.

This information can be found on the rating plate, so you have these numbers to hand we recommend you write them below.

Model

PNC no.

S no.

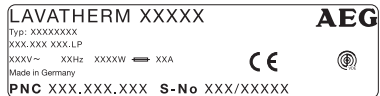

Customer care

For general enquiries regarding your AEG appliance, or for further information on AEG products please contact our Customer Care Department or visit our website at www.aeghome.co.uk

AEG Domestic Appliances
55-77 High Street
Slough
Berkshire SL1 1DZ
Tel: 08705 350350 *

* Calls to this number may be recorded for training purposes.

Index

A

Acrylate	23
Acrylic	27
AEG Service Force Centre	30
Anorak	22

C

Closing the door	25
Conditioning sheets	15
Connection	9
Control panel	19
COOL AIR	20
Cool-down phase	24
Crease protection phase	24
Customer care	36

D

Disposal	15
Door Reversal	31

E

Easy-care fabrics	27
Environmental protection	16

F

Fluff filter	25
Furniture polish	28

G

Glossary	27
Guarantee	34

I

Installation	7
--------------------	---

O

Opening the door	22
------------------------	----

P

Packaging	15
-----------------	----

R

Rating plate	36
--------------------	----

S

Safety Information	5
Service & Spare Parts	36
SPECIAL CARE	17, 27
Stacking kit	33
START button	23

T

Two-layer fabric	22
------------------------	----

V

Viscose	27
---------------	----

W

Wool	27
------------	----

The Electrolux Group is the world's largest producer of powered appliances for kitchen, cleaning and outdoor use. More than 55 million Electrolux Group products (such as refrigerators, cookers, vacuum cleaners, chain saws and lawn mowers) are sold each year to a value of approx. 14 billion USD in more than 150 countries around the world.



From the Electrolux Group. The world's No.1 choice.

AEG Hausgeräte GmbH
Postfach 1036
D-90327 Nürnberg

<http://www.aeg.hausgeraete.de>

© Copyright by AEG

822 944 090 -00- 0501/PRO